

Deakin Research Online

Deakin University's institutional research repository

This is the author's final peer reviewed version of the item published as:

Zhang, Yuping, Wang, Xungai, Pan, Ning and Postle, R. 2002-04, Weibull analysis of the tensile behavior of fibers with geometrical irregularities, *Journal of materials science*, vol. 37, no. 7, pp. 1401-1406.

Copyright : 2002, Kluwer Academic Publishers

Weibull Analysis of the Tensile Behavior of Fibers with Geometrical Irregularities

Yuping Zhang and Xungai Wang

School of Engineering & Technology, Deakin University, Geelong, Australia 3216

Ning Pan

Division of Textiles and Clothing, University of California, Davis, CA 95616, USA

Ron Postle

School of Materials Science & Engineering, University of New South Wales, Sydney, Australia 2052

ABSTRACT

This paper further develops the conventional Weibull/weakest-link model by incorporating the within-fiber diameter variation. This is necessary for fibers with considerable geometrical irregularities, such as the wool and other animal fibers. The strength of wool fibers has been verified to follow this modified Weibull /weakest-link distribution. In addition, the modified Weibull model can predict the gauge length effect more accurately than the conventional model.

Key words:

Modified Weibull distribution, fiber strength, within-fiber diameter variation, wool, gauge length effect

1. Introduction

Many factors contribute to the differences in fiber tensile behavior, including fiber geometrical shape, morphological structure and fiber fracture mechanism. Griffith first proposed that fracture initiates at flaws and the final failure is caused by the propagation of the crack from the flaw [7]. Unlike most brittle fibers that are geometrically uniform, natural fibers such as wool exhibit between-fiber and within-fiber diameter variation. Although it has been suggested that the fracture of wool is also caused by the propagation of a crack from a flaw [1,15] or from regions with high local stress concentration [14], previous works [16] indicated wool fibers also break where the diameter is minimum. In addition, our recent research suggests that between-fiber and within-fiber diameter variations of wool are closely related to its tensile behavior [23,28]. So both fiber flaws (morphological defects) and fiber diameter variations affect the tensile behavior, particularly for non-uniform fibers. The weakest point in a fiber could be where there is an internal flaw or where fiber diameter is small or a combination of both. If this weakest point reaches its breaking limit, then the whole fiber breaks. This “weakest link” concept was first proposed by Peirce to predict the strength and its variation of long cotton yarns [19]. Combining with this weakest-link concept, the simple Weibull/weakest-link distribution of the strength of a long fiber can be easily derived from the strength distribution of many independent unit links of the fiber [25]. It was claimed by Coleman [6] that Weibull distribution “fits most naturally the theory of breaking kinetics”.

Because of its simplicity and the consistency with the weakest link concept, the Weibull distribution has become a useful tool to explain the strength variation of fibers. It has been widely applied to geometrically uniform fibers, such as the so-called “classical fibers”

[4,8,18,27]. It has also been applied to time dependent polyester yarns [2], some polymeric fibers [17] as well as to natural coir fibers [12]. The strength variations of these uniform fibers are deemed to be caused by randomly distributed fiber flaws and defects.

The strength of materials decreases with an increase in size [12,13,21,27 etc]. This has been generally explained by the existence of a larger number of flaws in a larger material volume. By combining the classical Weibull distribution with the weakest link theory, the Weibull/weakest-link model can be utilized to predict the scale effect. However, it was often found that there are great discrepancies between strength predicted by the conventional Weibull model and the experimental data [13,20,26]. Thus the multi-modal and the three-parameter Weibull distributions as well as some other modified Weibull models were introduced to improve the accuracy of prediction [3,9,11,13,24].

Wool fibers are well known visco-elastic fibers and their diameters vary greatly not only among fibers but also along the fiber length. It is a good sample of fibers with geometrical irregularities. Although the Weibull model has been widely applied to many fibers, very limited work has been done [22] to verify that it is also applicable to wool fibers. No work has been reported on the applicability of the Weibull or the modified Weibull model to predicting the scale effect of wool fibers. This work first introduces an exponential parameter into the conventional Weibull model. The tensile behavior, particularly the strength of wool is verified to fit this modified Weibull model. The scale effect is then examined and it is shown that the gauge length effect on fiber strength can be accurately predicted by the modified Weibull model.

2. Theoretical background

2.1. Weibull distribution

Based on the weakest-link theory, Weibull [25] proposed a simple distribution of material strength x :

$$P = 1 - \exp\left[-n\left(\frac{x}{x_0}\right)^m\right] = 1 - \exp\left[-\frac{V}{V_0}\left(\frac{x}{x_0}\right)^m\right] \quad (1)$$

where P is the failure probability of a long fiber connected by n independent segments, x is generally the strength, V is the fiber volume, V_0 is the volume of a unit link or a segment, m is Weibull modulus and x_0 is scale parameter.

From this simple Weibull distribution, the average and CV value of x can be obtained:

$$\bar{x} = x_0 \left(\frac{V}{V_0}\right)^{-1/m} \Gamma[1 + (1/m)] \quad (2)$$

$$CV = \frac{\{\Gamma[1 + 2/m] - \Gamma^2[1 + (1/m)]\}^{1/2}}{\Gamma[1 + (1/m)]} \quad (3)$$

The CV of the variable x is determined by Weibull modulus only.

2.2. Gauge Length Effect

From the conventional Weibull distribution (equation (1)), for constant fiber diameter, the average value of the variable x at gauge length L_2 can be calculated from that at gauge length L_1 :

$$\bar{x}_2 = \bar{x}_1 \left(\frac{L_2}{L_1} \right)^{-1/m} \quad (4)$$

where x_1 and x_2 are the fiber strengths at gauge length L_1 and gauge length L_2 respectively.

The gauge length effect predicted by this formula deviates greatly from the actual value [13,20,26]. Watson and Smith [24] as well as Gutans and Tamuzs [10] introduced a modified Weibull model (the WSGT function named by Wagner [21]):

$$P = 1 - \exp\left[-\left(\frac{L}{L_0}\right)^\beta \left(\frac{x}{x_0}\right)^m\right] \quad (5)$$

where L is the gauge length, L_0 is the length of the unit link of the fiber. β is a parameter ($0 < \beta < 1$) that was proposed by Watson and Smith [24] to represent the diameter variations. However, the exact physical meaning of this parameter (β) was not pointed out clearly as stated by Wagner [21].

The prediction of the gauge length effect from this modified Weibull model is then:

$$\bar{x}_2 = \bar{x}_1 \left(\frac{L_2}{L_1} \right)^{-\beta/m} \quad (6)$$

The conventional (equation (1)) and many modified Weibull models (equation (5), etc) are widely applied to uniform brittle and polymeric fibers. Wool is quite different from these fibers especially in its variable geometrical structure. Hence it is necessary to examine how the tensile behavior of wool fits the Weibull model after incorporating its distinct diameter variations.

3. Materials and Methods

3.1. Materials

Fibers investigated in this work are randomly extracted from a merino wool top after a top dyeing process.

3.2. Methods

Individual fibers were randomly and gently withdrawn from the top after they were conditioned for more than 24 hours at $20 \pm 2^\circ\text{C}$ and $65\% \pm 2\%$ relative humidity environment. Then the fiber diameters of each single fiber were measured at $40 \mu\text{m}$ intervals along its length on the Single Fiber Analyzer (SIFAN) (BSC Electronics).

When measuring fiber diameters on SIFAN, the fiber ends near two jaws are not accessible to the CCD camera on the SIFAN instrument. This may lead to inaccurate results for within-fiber diameter variations, especially for fibers with a short measuring length. To eliminate this problem, each fiber was marked at two points, and the distance

(L) between the two marks is shorter than the fiber length (L') between the jaws (Fig. 1). This ensures that the fiber section between the marks is fully scanned for fiber diameter, and only this section (with a length L) will be used for tensile testing.

The relevant SIFAN settings used in the experiments are given below:

Pre-tension: 1 cN
Diameter scanning: every 40 μm along fiber length
Fiber length (L): 10 mm, 20mm, 50mm, 100mm

After the diameter measurements, single fibers were then tested for tensile properties on an INSTRON extensometer with the following settings:

Cross-head speed: 20mm/min
Gauge length: 10mm, 20mm, 50mm, 100mm

All tests were conducted under standard environmental conditions (20 ± 2 °C and $65 \pm 2\%$ RH). The values for fibers that broke at or near the jaws are discarded.

4. Results and Discussion

4.1. A new modified Weibull model

The mean diameter, the coefficient of variations of diameter along the fiber CV_D , and tensile properties of the wool fibers at gauge lengths of 10mm, 20mm, 50mm and 100mm respectively are listed in Table 1.

The mean diameter in Table 1 is the average diameter of N fibers, in which the diameter for every fiber is the average value of the diameters measured at 40 μm intervals along the fiber length. The CV_D is the average within-fiber diameter variation of N fibers in which the within-fiber diameter variation of every fiber is based on the diameters measured at 40 μm intervals along the fiber length.

The gauge length effect is apparent from Table 1. The average values of breaking force, strength and breaking strain all decrease with the increasing gauge length. Interestingly, the within-fiber diameter variations increase with the increasing gauge length. Our previous work showed that the within-fiber diameter variation has a negative impact on fiber fracture properties for fibers with a similar mean diameter [28]. It is naturally inferred from these results that the gauge length effect is not only caused by the large number of flaws but also by the increased within-fiber diameter variation at the long gauge length. The change of the average within-fiber diameter variation with the gauge length is further examined and shown in Fig. 2.

Fig. 2 shows that the average within-fiber diameter variation increases exponentially with the gauge length. Also the correlation coefficient of the logarithm of within-fiber diameter variation and that of the gauge length is very high ($r^2=99.47\%$). The following relationship between them can be obtained as:

$$\ln(CV_D)=18.14 \times 10^{-2} \ln(L)+1.78 + \varepsilon \quad (\varepsilon \text{ is a random error}) \quad (7)$$

$$\text{So, } CV_D = A\chi L^\lambda \quad (8)$$

where A is a constant, $\chi = e^\varepsilon$ and $\lambda=18.14 \times 10^{-2}$, for the wool fiber examined.

From equation (8), for a specified type of fibers measured under different gauge lengths,

$$\frac{CV_{D1}}{CV_{D2}} = \frac{\chi_1}{\chi_2} \left(\frac{L_1}{L_2}\right)^\lambda \propto \left(\frac{L_1}{L_2}\right)^\lambda \quad (9)$$

Since the within-fiber diameter variation is the exponential function of the gauge length, it should not be ignored in predicting the gauge length effect. The parameter β in the WSGT model (equation (5)) is replaced by the parameter λ and the equation (6) has been changed to:

$$\bar{x}_2 = \bar{x}_1 \left(\frac{L_2}{L_1}\right)^{-\lambda/m} \quad (10)$$

And the corresponding modified Weibull distribution is:

$$P = 1 - \exp\left[-\left(\frac{V}{V_0}\right)^\lambda \left(\frac{x}{x_0}\right)^m\right] \quad (11)$$

where λ is the exponential parameter of the change of within-fiber diameter variation with the gauge length. Therefore, this modified equation has not only considered the diameter variation between the fibers ($V = \frac{1}{4} \pi D^2 L$, ignoring the slight ellipticity of fibre cross section), but also the within-fiber diameter variation (λ). What follows is a verification of this modified Weibull model (equation (11)) that incorporates the within-fiber diameter variation.

4.2. Verification of the modified Weibull distribution

Considering that fiber diameter changes from fiber to fiber under a fixed gauge length, fiber volume V is not a constant. Assuming $y=xV^{\lambda/m}$, then equation (11) becomes:

$$P = 1 - \exp\left[-\left(\frac{y}{y_0}\right)^m\right] \quad (12)$$

$$\text{where, } y_0 = x_0 V_0^{\lambda/m}$$

So,

$$\ln(-\ln(1-P)) = m \ln(y) - m \ln(y_0) = m \ln(x) + \lambda \ln(V) - m \ln(y_0) \quad (13)$$

From equation (13), $\ln(y)$ is linearly proportional to $\ln(-\ln(1-P))$ and the slope is the Weibull modulus m .

The method to obtain the Weibull modulus is adopted from that of Wagner [21], using the following procedure:

- Give an estimated Weibull modulus m' , then each y value can be calculated from x and V ($V = \frac{1}{4} \pi D^2 L$) of each fiber according to $y = x V^{\lambda/m'}$.

- Assign P_o ($P_o = i/(N+1)$, $i=1,2,\dots,N$) to every ascending y value.

- Plot $\ln y$ versus $\ln(-\ln(1-P_o))$, the slope of this plot m can be obtained. If $m \neq m'$, then iterate the procedures above until $m = m'$. The Weibull modulus is that when m is equal to m' .

The goodness-of-fit test is carried out by using the Kolmogorov-Smirnov test. The procedure is:

- (1) Determine the maximum deviation (D_n) between P_o from $P_o=i/(N+1)$ and P from the modified Weibull probability (equation (11)).

$$D_n = \text{Max} |P_o - P|$$

- (2) The critical value D_{nc} can be obtained from Kolmogorov-Smirnov test table. For $N>35$ and a significance level of $\alpha=0.05$,

$$D_{nc} = \frac{1.36}{N^{\frac{1}{2}}}$$

- (3) If $D_n < D_{nc}$, the null hypothesis that the observed data follow the Weibull distribution is accepted.

The Weibull plots of $\ln(-\ln(1-P))-\lambda*\ln(V)$ versus $\ln(x)$ for fiber strength and breaking strain at 10mm, 20mm, 50mm and 100mm gauge lengths are shown in Fig. 3 and Fig. 4 respectively, in which $k=\lambda$.

The Weibull parameters and K-S goodness of fit test are listed in Table 2. The fiber strengths at four different gauge lengths all fit the modified Weibull distribution (equation (11)), while the breaking strain at 10mm and 20mm gauge lengths failed the test. The gauge length effect on fiber strength is compatible with the weakest link concept. However, the breaking strain of a fiber is not the strain at the position of flaw or minimum

fiber diameter but the average strain of every fiber segments when the fiber breaks [5,28]. Therefore, the weakest link theory does not apply well to the breaking strain.

The strength of this merino wool can be well represented by the modified Weibull distribution. That means the distribution of its strength can be determined by Weibull modulus m , scale parameter and another parameter λ —the exponential parameter of the change of the within-fiber diameter variation with the gauge length. If the distribution is known, then the average and the variation of the strength can be obtained using equations (2) and (3).

4.3. Gauge length effect

Fig. 5 shows that the tensile strength and the breaking strain of this merino wool decrease with the increasing gauge length. So there exists the gauge length effect. The modified Weibull model can predict the gauge length effect on the fiber strength because it fits the distribution very well.

In order to predict the average strength at different gauge lengths simply from that at another gauge length, the diameter variation among fibers can be ignored because their average diameter at each gauge length should be close to each other when the sample size is large. The predictions of the gauge length effect from our modified Weibull model (equation (11)) are compared in Fig. 6 and Fig. 7 with that from the conventional Weibull model (equation (1)) and the experimental values.

Fig. 6 and Fig. 7 clearly show that the modified model, incorporating the within-fiber diameter variation, can predict the gauge length effect more accurately than the conventional Weibull distribution. Therefore, if the average fiber strength at one gauge length is known, then its average strength at another gauge length can be predicted. This is particularly significant when the fiber strength at very short gauge length, which is difficult to achieve experimentally, is needed.

5. Conclusions

A new modified Weibull model is introduced in this work, which incorporates not only the diameter variation among fibers but also the within-fiber diameter variation. The fiber strength of merino wool from a dyed top has been verified to fit this modified Weibull/weakest-link model. In addition, the gauge length effect on the fiber strength can be more accurately predicted from the modified Weibull model than from the conventional Weibull model.

REFERENCES

1. M. W. Andrews, *Text. Res. J.* **34** (1964) 831-835.
2. G. Amaniampong and C. J. Burgoyne, *J. of Mater. Sci.* **29** (1994) 5141-5152.
3. E. Bourgain and J. J. Masson, *J. of Mater. Sci.* **27** (1992) 1811-1817.
4. M. G. Bader and A. M. Priest, in *Proc. of ICCM-IV* (Tokyo, 1982) 1129-1136.
5. E. C. Banky and S. B. Slen, *Text. Res. J.* **25** (1955) 358-361.
6. B. D. Coleman, *J. Mech. and Phy. of Solids* **7** (1958) 60-70.
7. A. A. Griffith, *Phil. Trans. Roy. Soc.* **A221** (1920) 163-198.
8. M. R. Gurvich, A. T. Dibenedetto and A. Pegoretti, *J. of Mater. Sci.* **32** (1997a) 3711-3716.
9. M. R. Gurvich, A. T. Dibenedetto, and S. V. Ranade, *J. of Mater. Sci.* **32** (1997b) 2559-2564.
10. J. Gutans and V. Tamuzs, *Mech. Compos. Mater.* **20** (1984) 1107.
11. W. F. Knoff, *J. of Mater. Sci.* **28** (1993) 931.
12. A. G. Kulkarni, K. G. Satyanarayana and P. K. Rohatgi, *Fiber Sci. and Tech.* **19** (1983) 59-76.
13. V. Lavaste, J. Besson and A. R. Bunsell, *J. of Mater. Sci.* **30** (1995) 2042-2048.
14. K. R. Makinson, *J. Text. Inst.* **61** (1970) 151-153.
15. P. Mason, *Text. Res. J.* **34** (1964) 747-754.
16. D. F. G. Orwin, J. L. Woods and K. H. Elliott, in *Proc. 6th Int. Wool Text. Res. Conf.* **2** (Pretoria, 1980) 193-205.
17. N. Pan, H. C. Chen, J. Thompson, M. K. Inglesby, S. Khatua, X. S. Zhang, S. H. Zeronian, *J. of Mater. Sci.* **32** (1997) 2677-2685.
18. S. N. Patankar, *J. of Mater. Sci. Letters* **10** (1991) 1176-1181.

19. F. T. Peirce, *J. Text. Inst.* **17** (1926) T355-T368.
20. P. Schwartz, A. Netravali and S. Sembach, *Text. Res. J.* **56** (1986) 502-508.
21. H. D. Wagner, in “Application of Fracture Mechanics to Composite Materials”, edited by K. Friedrich, Chapter 2 (Elsevier Science Publishers B.V., 1989) p.39-77.
22. X.Wang, Y. Zhang, R. Postle and N. Pan, in *Proc. 2nd China Int. Wool Text. Conf.* **1** (Xian, P.R,China, 1998) 277-281.
23. X. Wang, *Text. Res. J.* **70(3)** (2000) 191-194.
24. A. S. Watson and R. L. Smith, *J. of Mater. Sci.* **20** (1985) 3260-3270.
25. W. Weibull, *J. Appli. Mech.* **27** (1951) 293-297.
26. D. M. Wilson, *J. of Mater. Sci.* **32** (1997) 2535-2542.
27. H. F. Wu and A. N. Netravali, *J. of Mater. Sci.* **27** (1992) 3318-3324.
28. Y. Zhang and X. Wang, *Wool Technology & Sheep Breeding*, 48 (2000) 303-312.

List of Tables and Figures

Table 1: Fiber diameter, within-fiber diameter variation and tensile behavior

Table 2: The Weibull parameters and K-S goodness-of-fit test

Figure 1: A diagram illustrating the diameter and tensile tests

Figure 2: Change of within-fiber diameter variation with the gauge length

Figure 3: The modified Weibull plot of the fiber strength

Figure 4: The modified Weibull plot of the breaking strain

Figure 5: Gauge length effect

Figure 6: A comparison between the experimental and the predicted values of average fiber strength (predictions are based on the results at 10 mm gauge length)

Figure 7: A comparison between the experimental and the predicted values of average fiber strength (predictions are based on the results at 100 mm gauge length)

Table 1 Fiber diameter, within-fiber diameter variation and tensile behavior

Gauge Length (mm)	Mean Diameter (μm) (CV)	CV _D within the fiber (%) (CV)	Breaking Force (mN) (CV)	Fiber Strength (MPa) (CV)	Breaking Strain (%) (CV)
10mm (N=126)	24.9 (17.0%)	9.1 (19.5%)	66.9 (41.2%)	213.8 (17.6%)	50.8 (28.3%)
20mm (N=153)	25.0 (18.4%)	10.2 (18.8%)	62.5 (43.6%)	213.4 (17.8%)	37.1 (37.4%)
50mm (N=37)	24.5 (13.1%)	11.9 (19.3%)	50.5 (32.6%)	205.4 (14.0%)	25.6 (44.0%)
100mm (N=51)	26.0 (15.1%)	13.9 (18.0%)	49.0 (36.4%)	201.4 (18.3%)	19.1 (49.4%)

(N: sample number)

Table 2 The Weibull parameters and K-S goodness-of-fit test

Gauge Length (mm)		Weibull modulus m	Scale parameter y_0	D_n	D_{nc}
10	Strength	6.6	197.2	0.05	0.12
	Breaking strain	2.9	41.4	0.17	
20	Strength	6.7	201.3	0.06	0.11
	Breaking strain	2.2	29.1	0.14	
50	Strength	7.9	199.2	0.06	0.22
	Breaking strain	1.9	20.6	0.10	
100	Strength	6.3	198.8	0.11	0.19
	Breaking strain	1.9	16.4	0.08	

(Zhang/Wang/Pan/Postle)

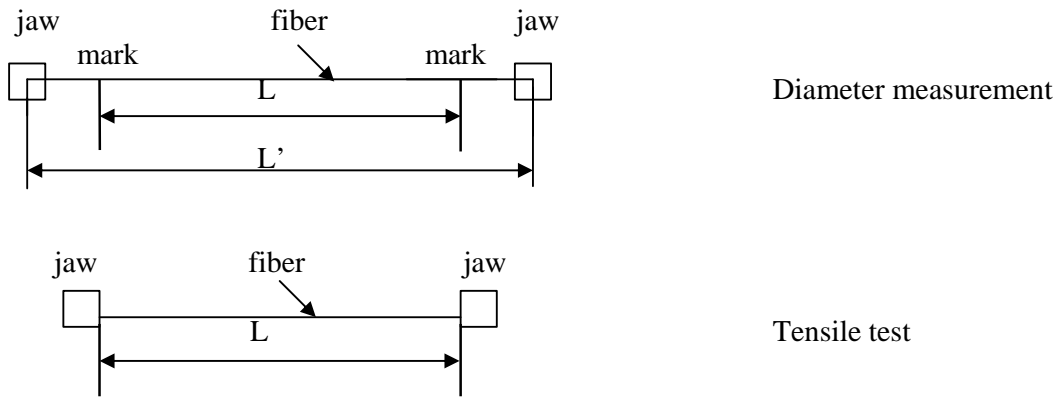

Fig. 1: A diagram illustrating the diameter and tensile tests

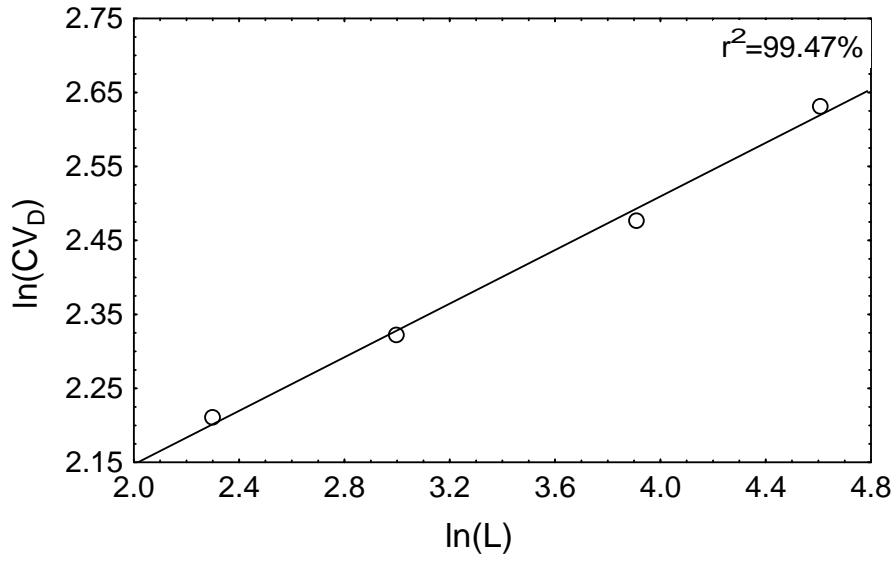

Fig. 2 Change of within-fiber diameter variation with the gauge length

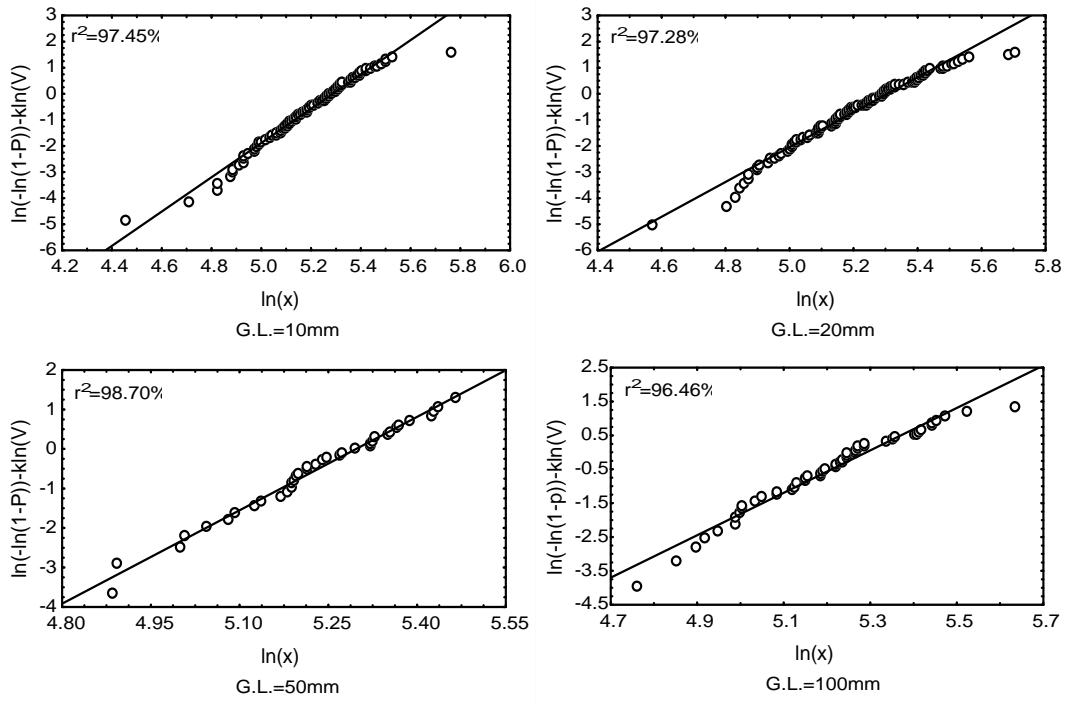

Fig. 3 The modified Weibull plot of the fiber strength

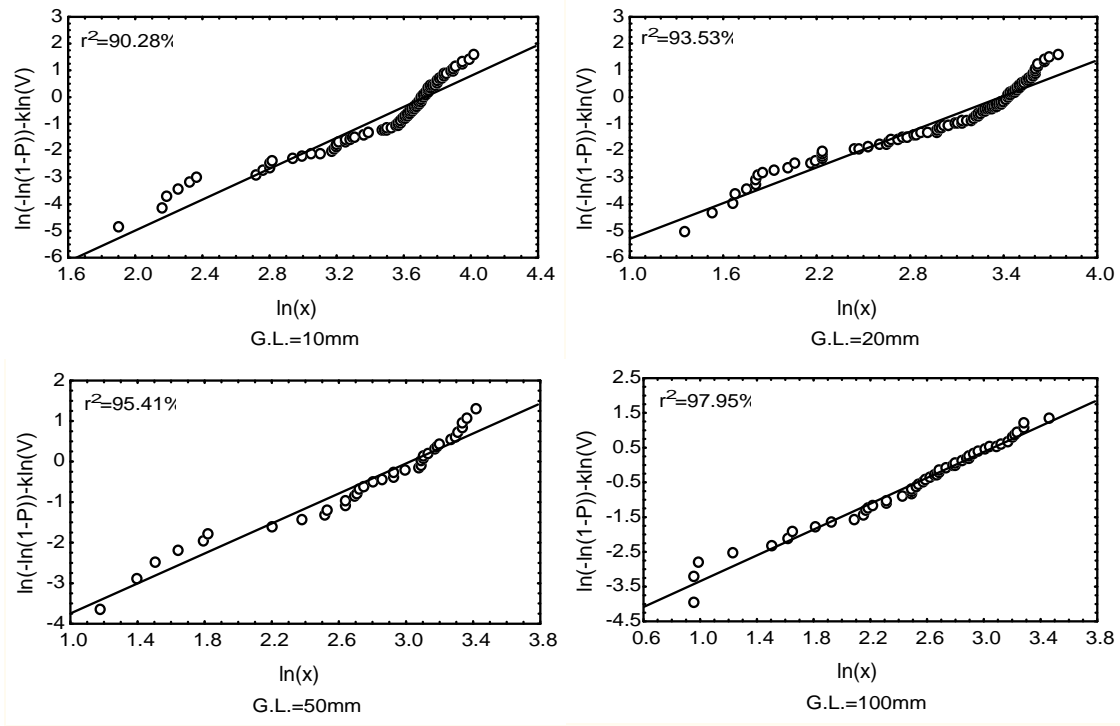

Fig. 4 The modified Weibull plot of the breaking strain

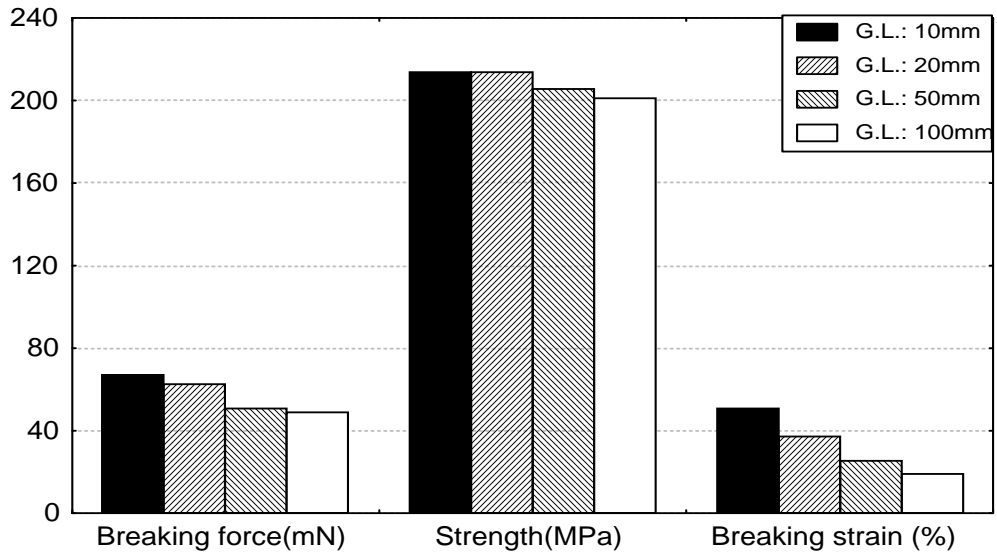

Fig.5 Gauge length effect

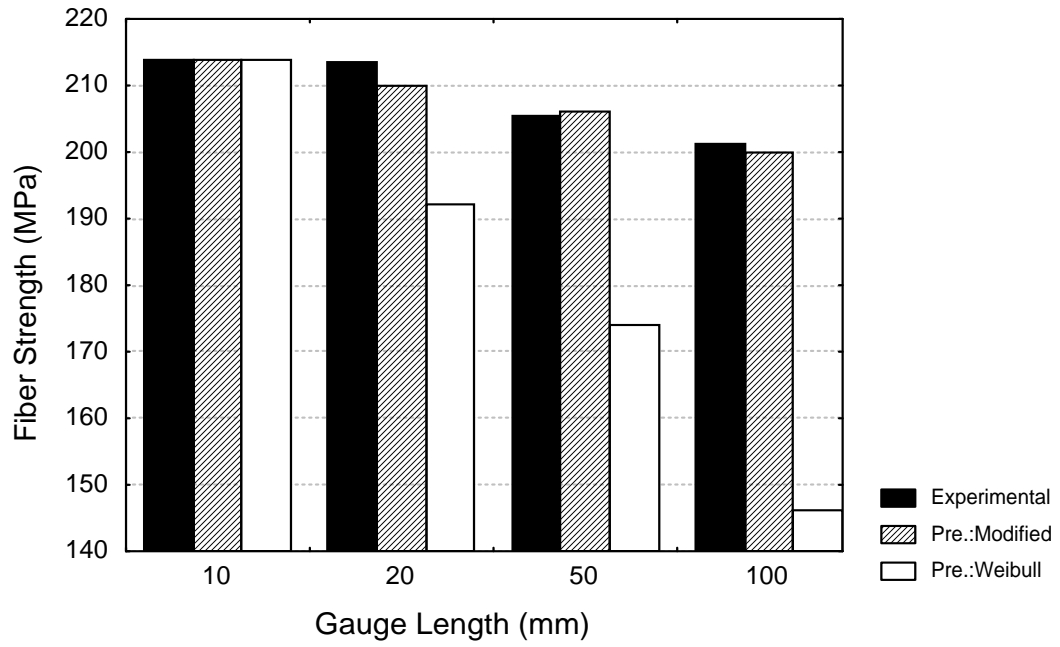

Fig. 6 A comparison between the experimental and the predicted values of average fiber strength (predictions are based on the results at 10 mm gauge length)

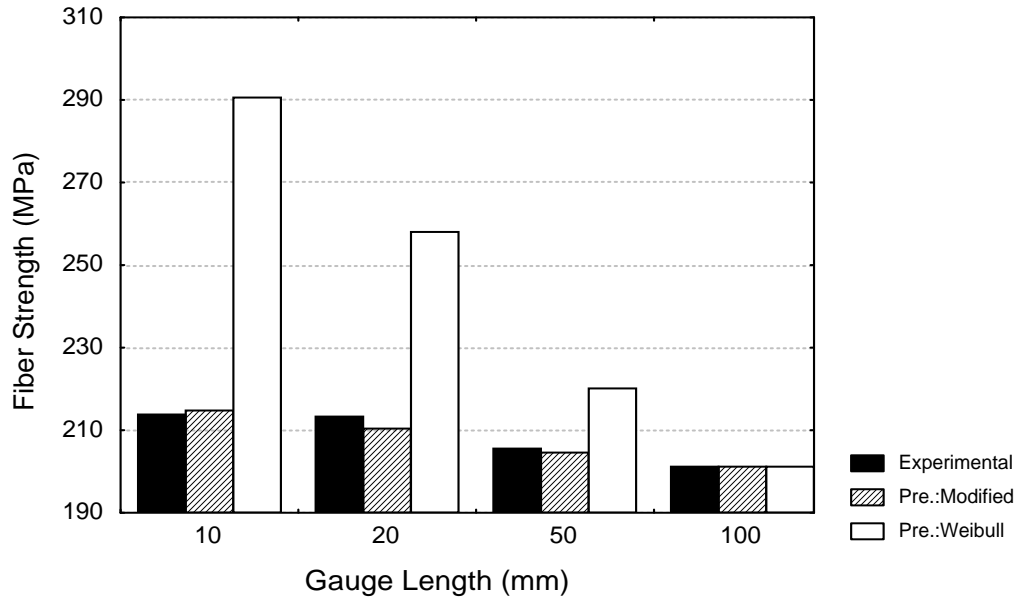

Fig. 7 A comparison between the experimental and the predicted values of average fiber strength (predictions are based on the results at 100 mm gauge length)